

1

L1 x3

T6 x24

M1 $\phi 15 \times 12 \text{mm}$ x12

T1 5x39mm x12

B1 $\phi 8 \times 28$ x20

C2 x12

W1 x18

W10 x6

S0 2,5x12 x6

M6 x16

P16 4,2x13 x16

C1 $\phi 2$ x8

K1 7x50 x8

2

F7 x2

S12 3x13 x2

P3 3,5x18 x10

3

E9 x1

E1 6,3x11 x5

E11 x1

4

E5 x1

E1 6,3x11 x5

A1 x2

5

E7 x2

E1 6,3x11 x10

E12 x2

S10 3,5x25 x4

L2 L=1161 mm X1

J22 L=2096 mm X1

6

E8 x2

E1 6,3x11 x4

7

E6 x2

E1 6,3x11 x4

8

S3 3,5x13 x9

S12 3x13 x32

L4 x2

L3 L=2154 mm x2

P13 3,5x13 mm x40

9

J11 x2

P13 3,5x13 mm x4



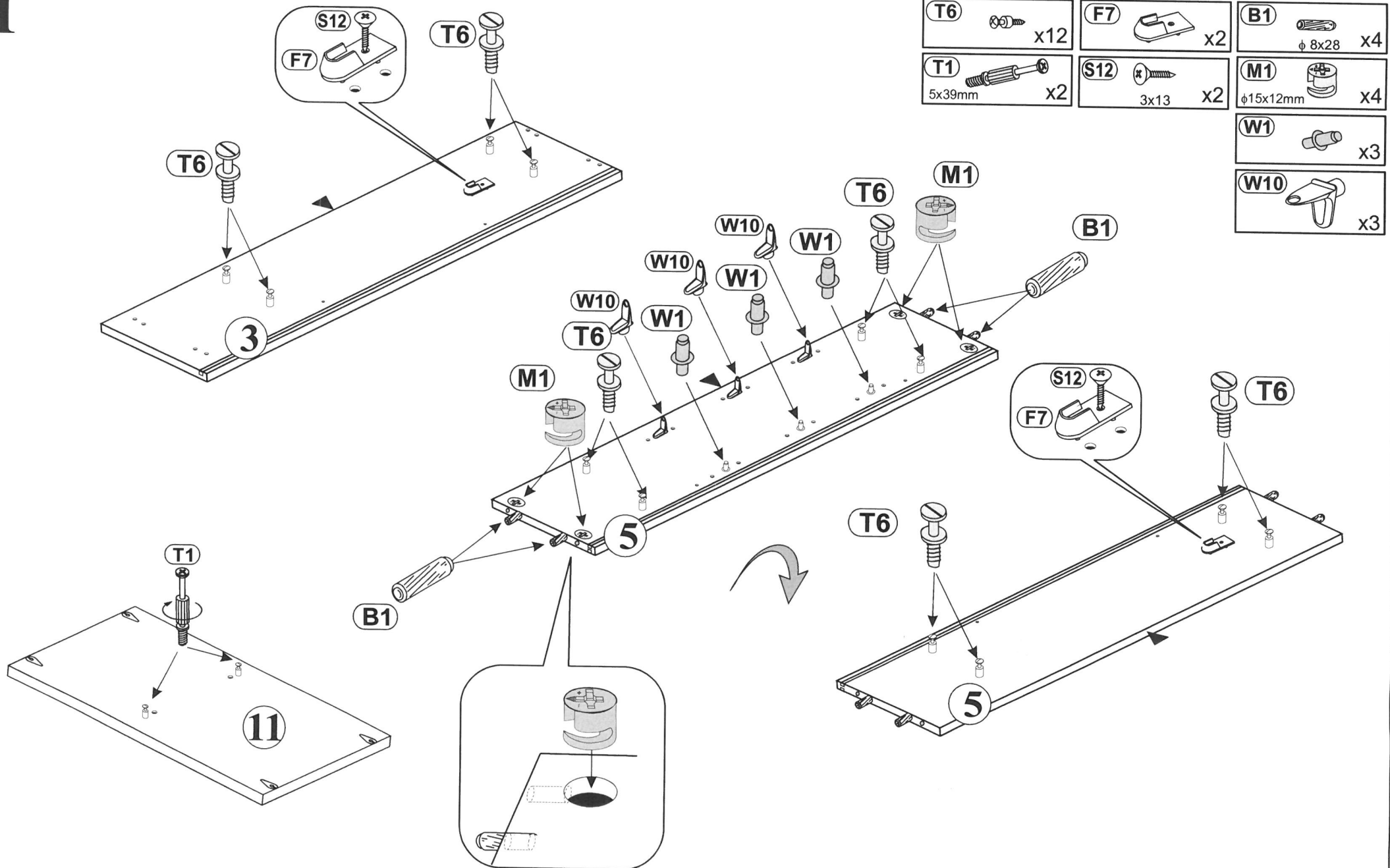

1





2

T6  x12

B1  x8
φ 8x28

M1  x8
φ15x12mm

W1  x15

W10  x3

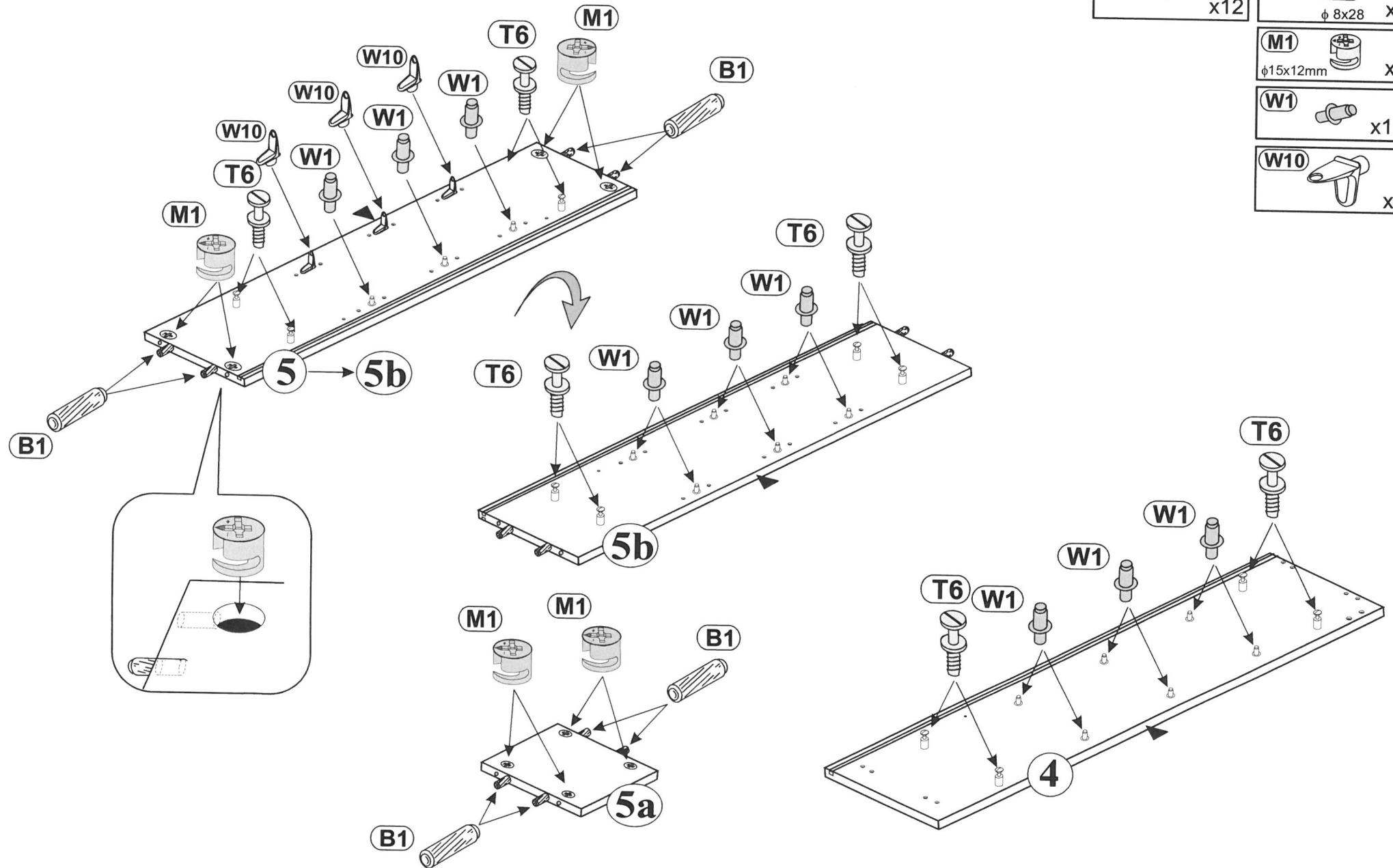

3

P3  3,5x18 x10

B1  ϕ 8x28 x8

L1  GLUE LEM x3

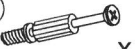
T1  5x39mm x10

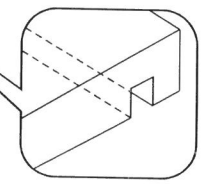
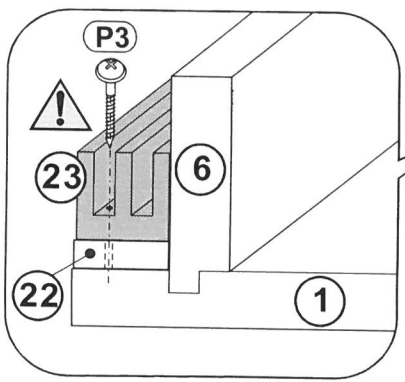
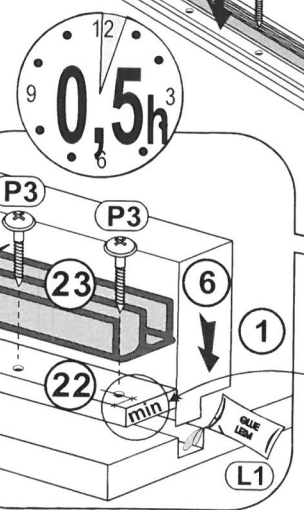
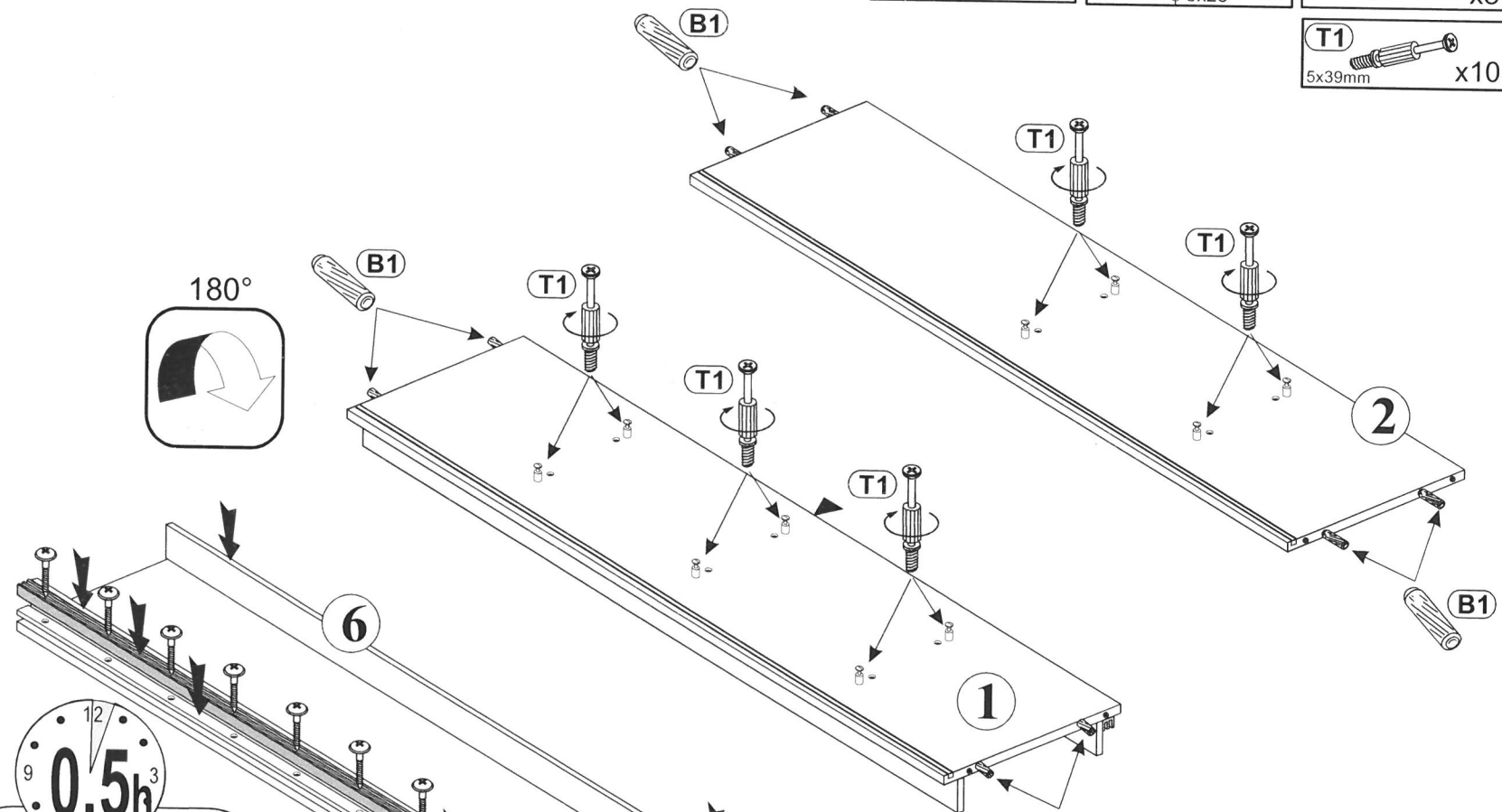
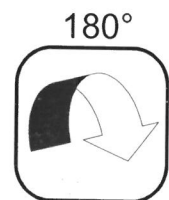

4

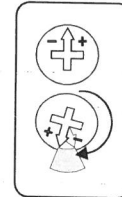
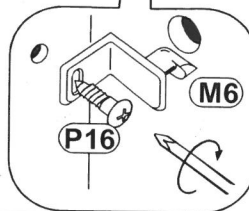
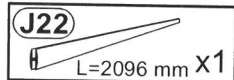
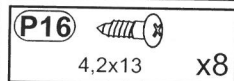
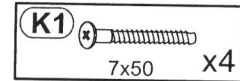
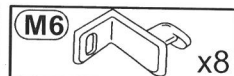
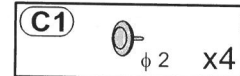
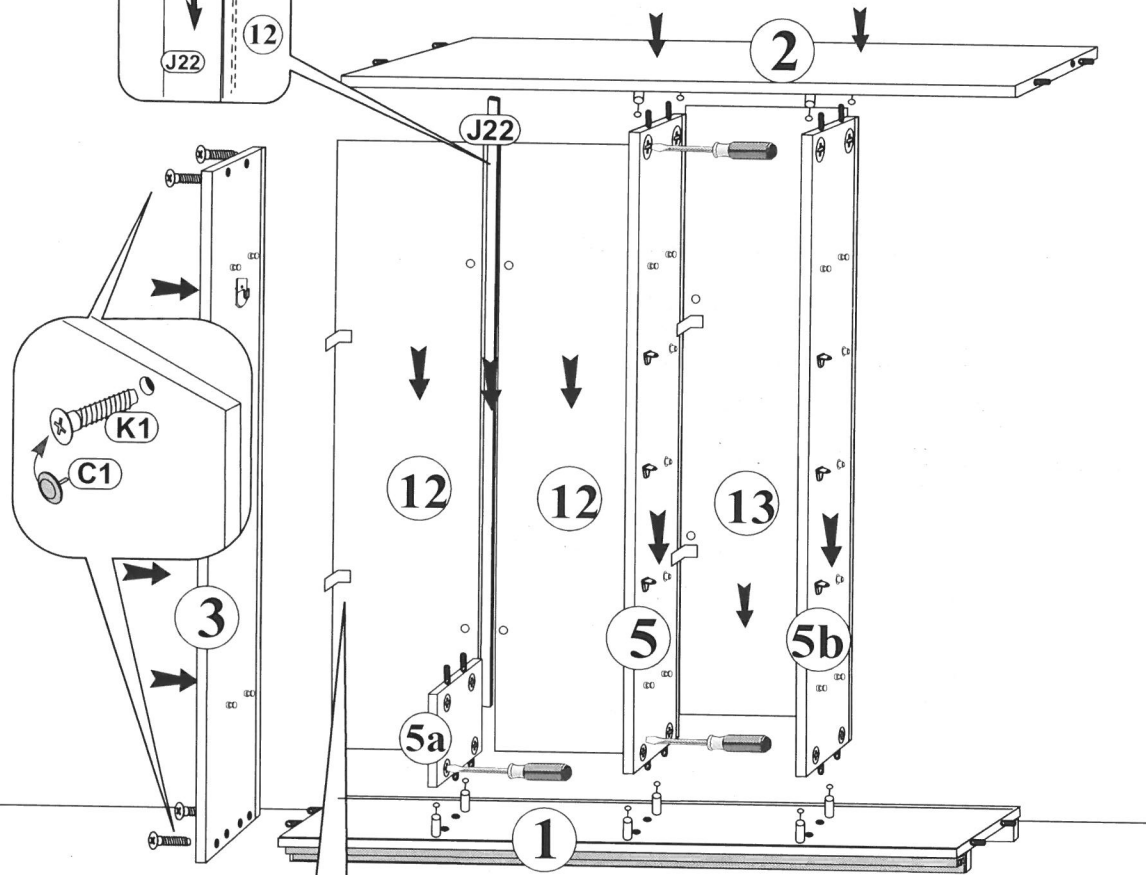
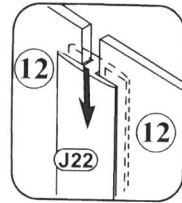
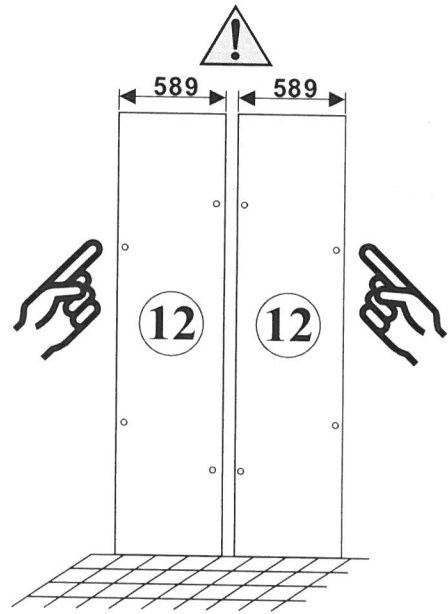
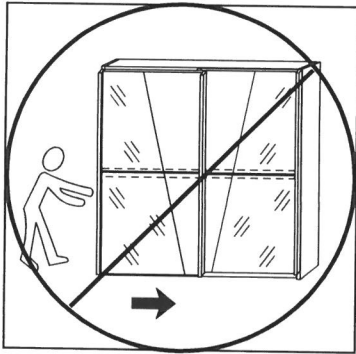

5

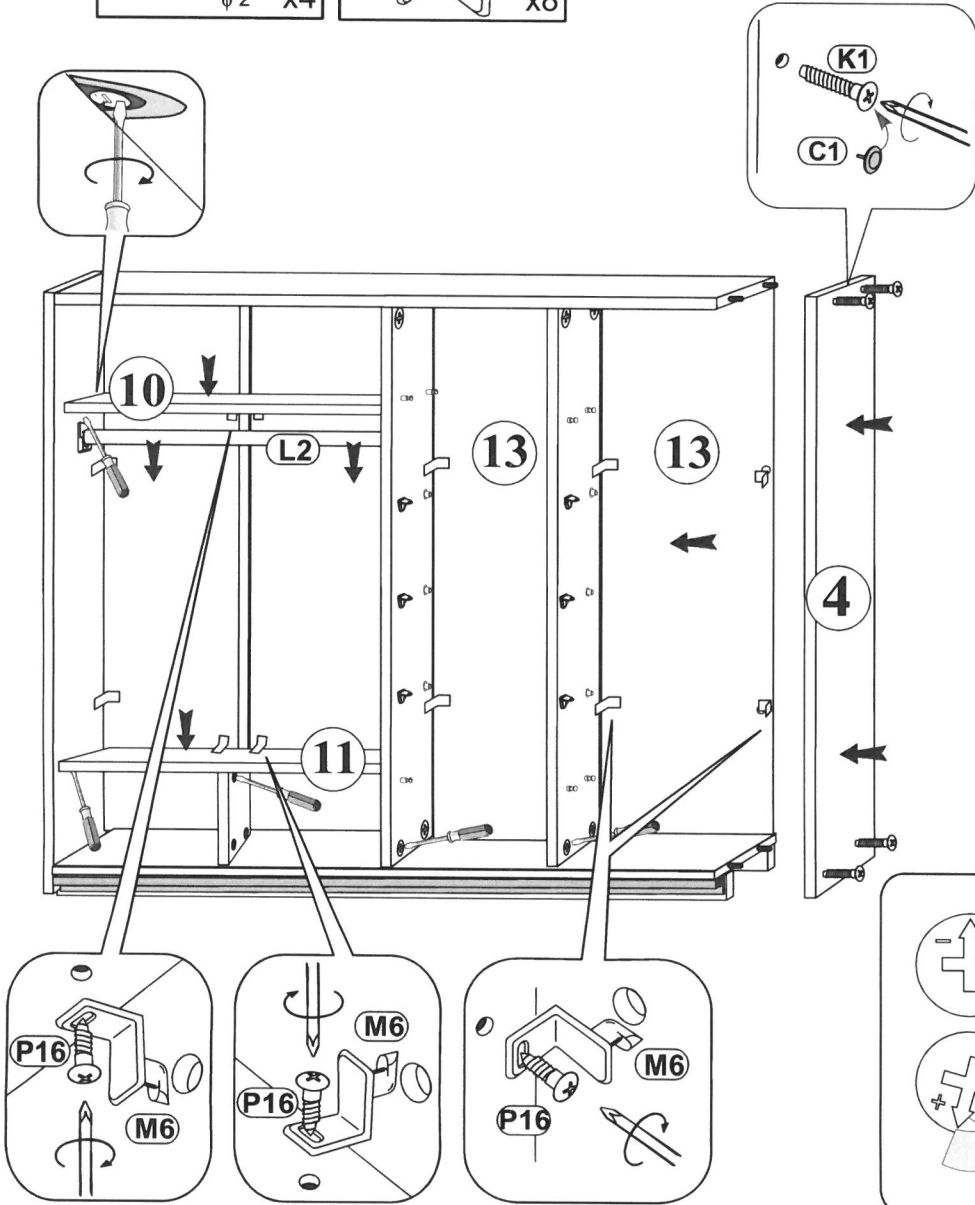
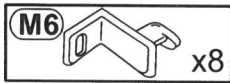
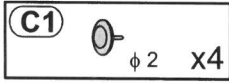
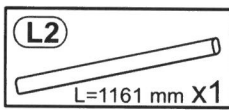
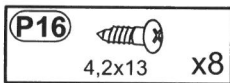
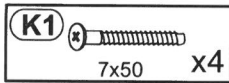

6

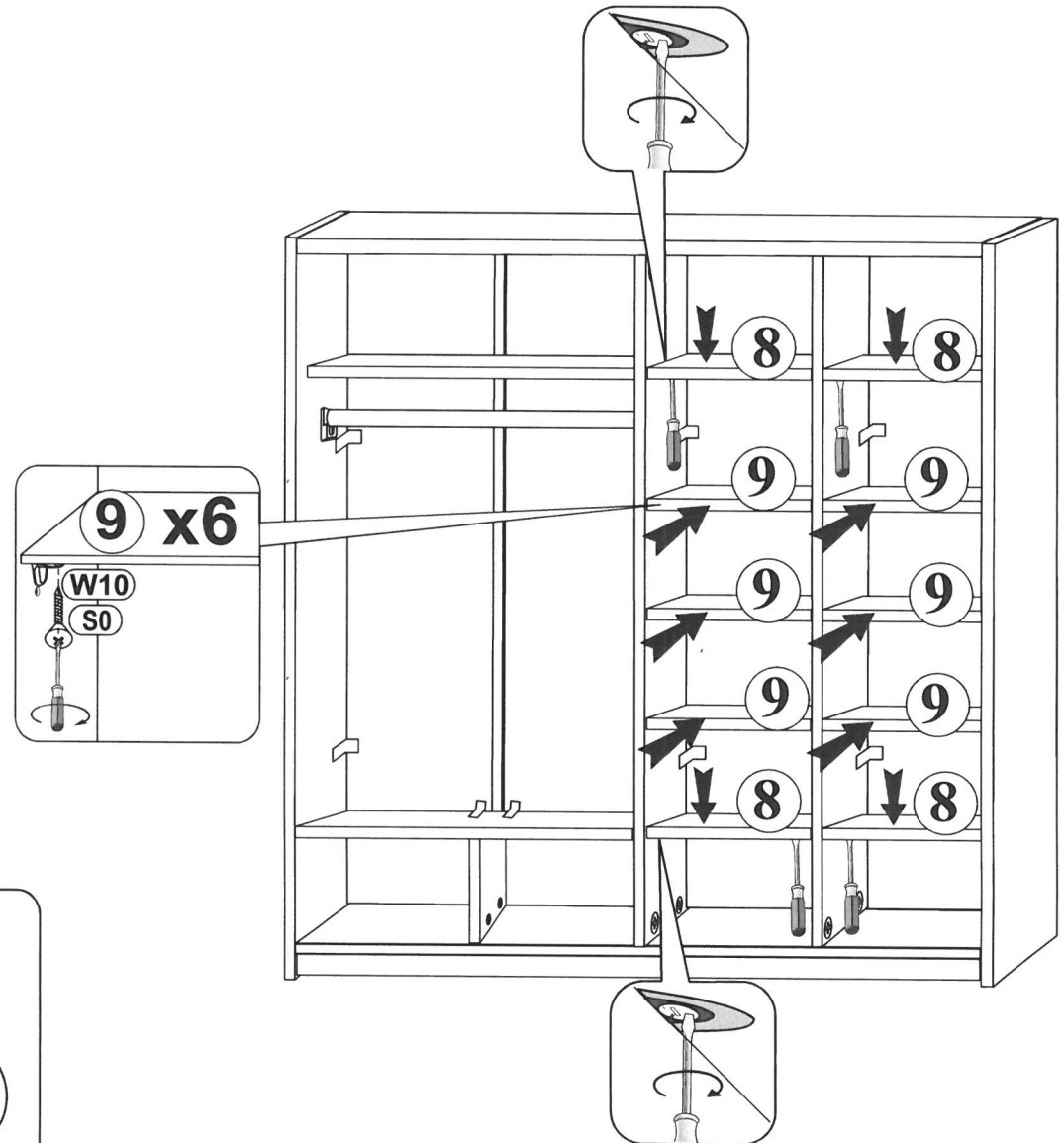
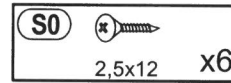

7

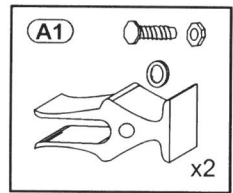
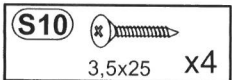
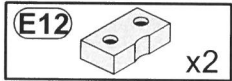
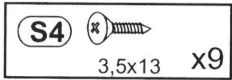

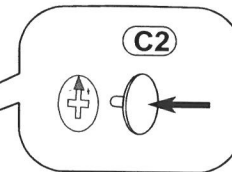
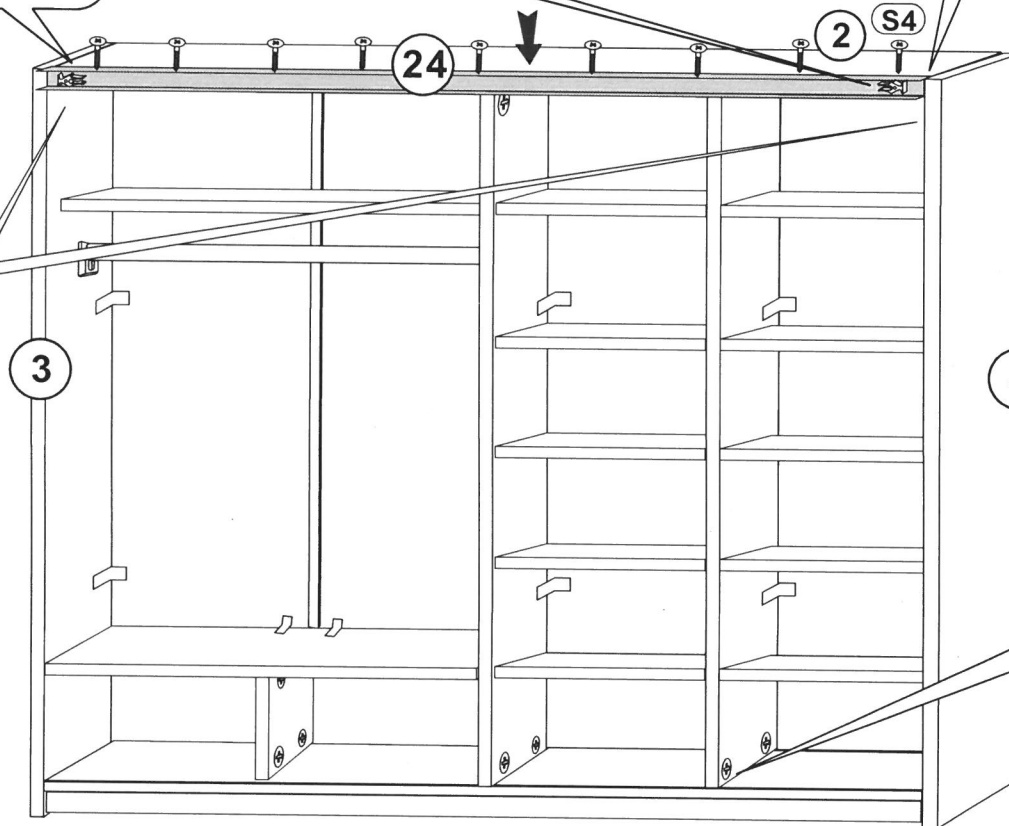
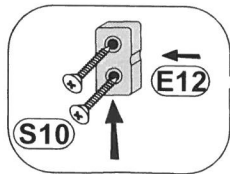
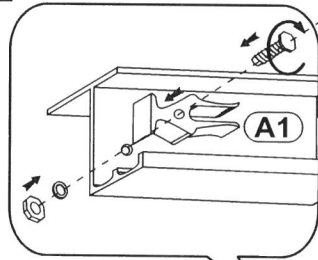
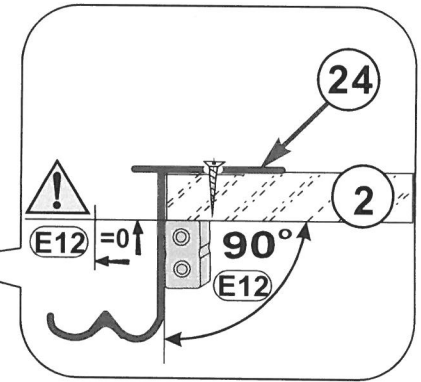
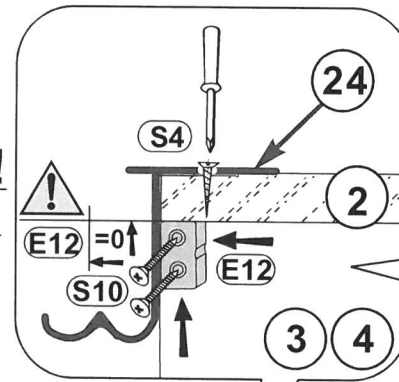

24

ACHTUNG!!!
ATTENTION!!!
UWAGA!!!



8

P13  3,5x13 mm x20

E1  6,3x11 x14

E8  x2

E7  x2

L3  L=2154 mm x1

S12  3x13 x18

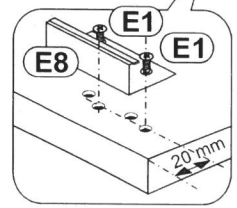
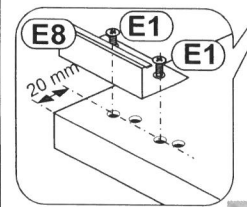
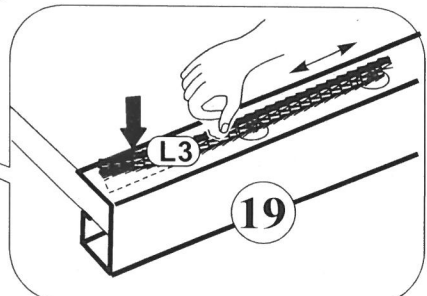
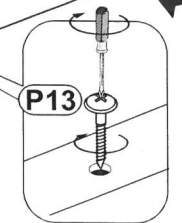
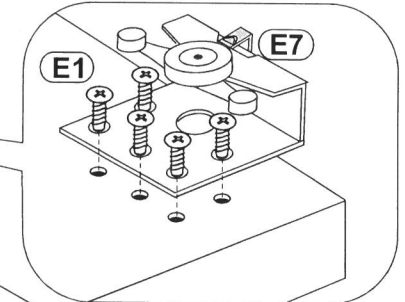
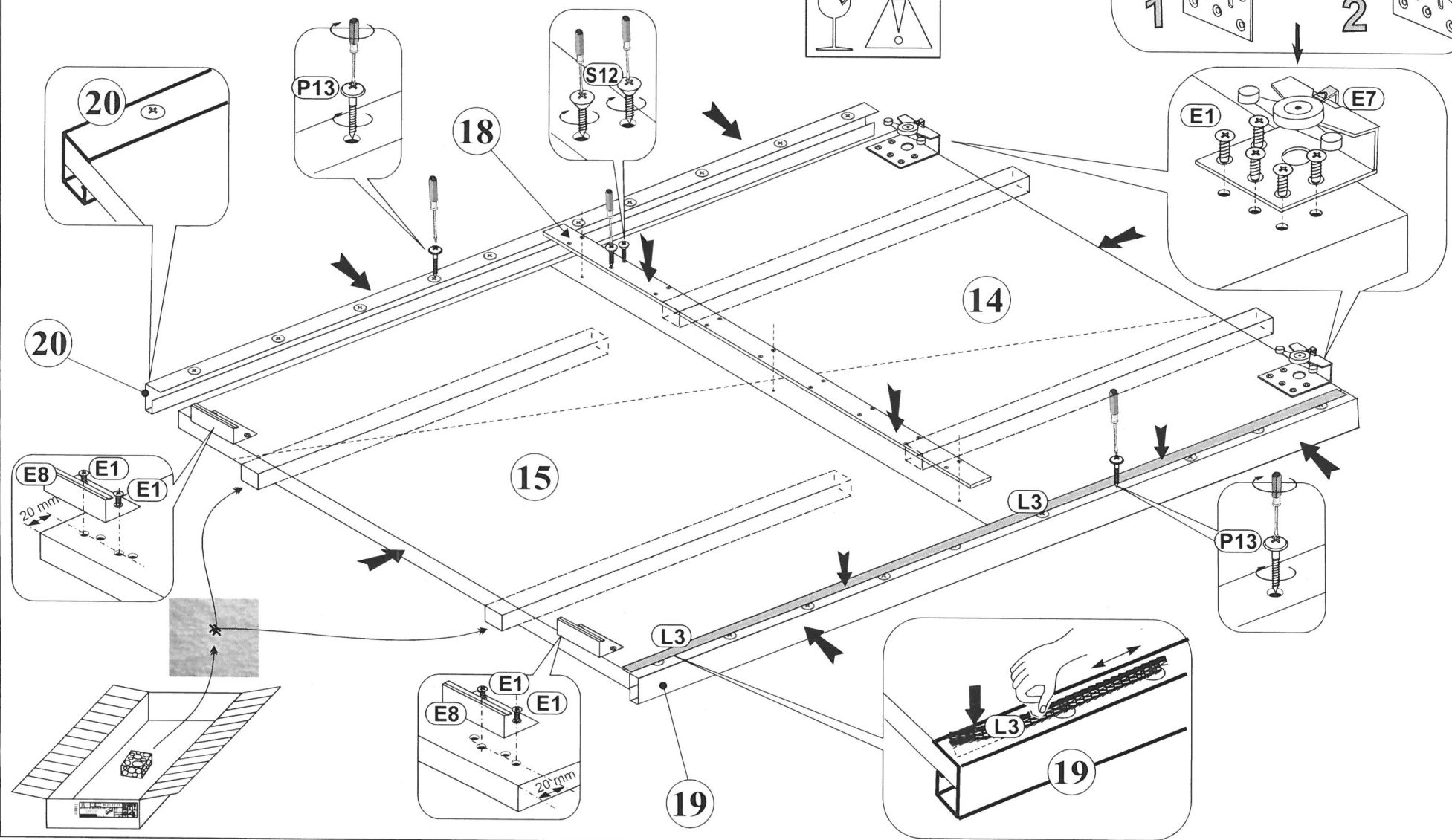
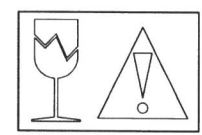
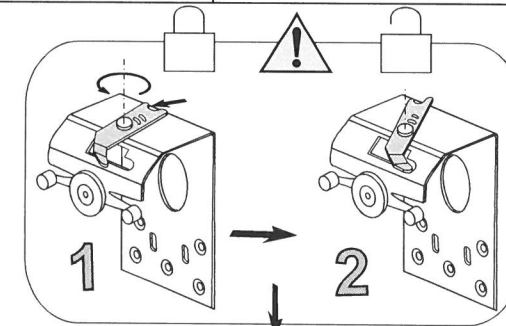

9

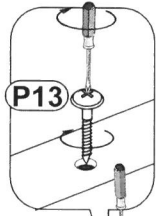
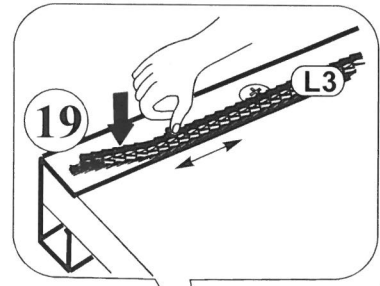
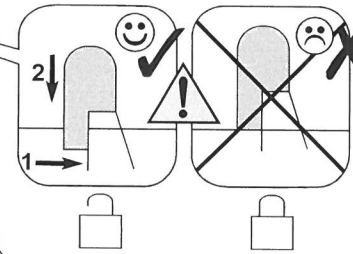
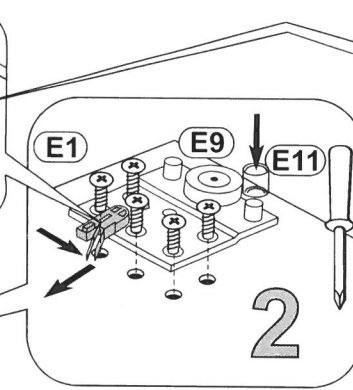
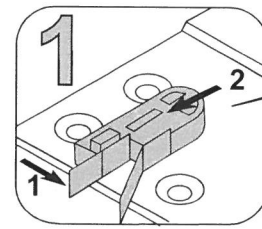
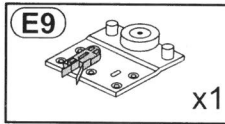
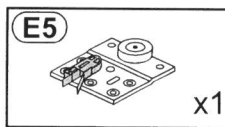
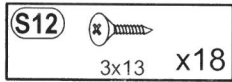
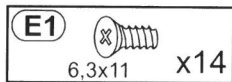
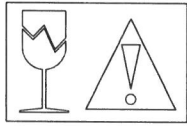
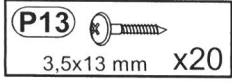
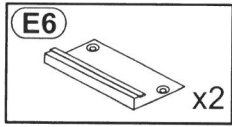

18

19

L3

16

17

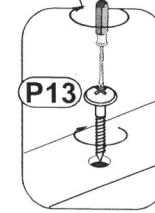
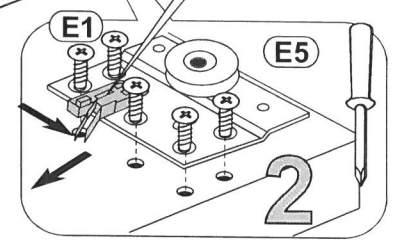
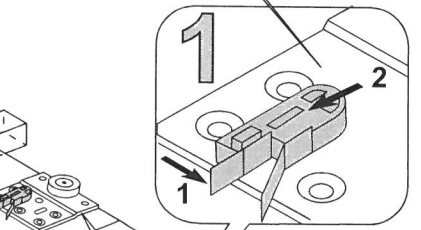
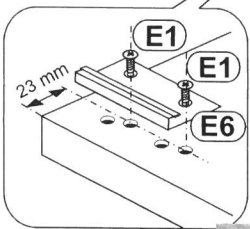

21

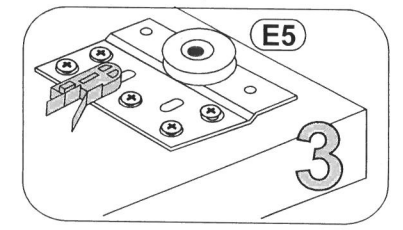
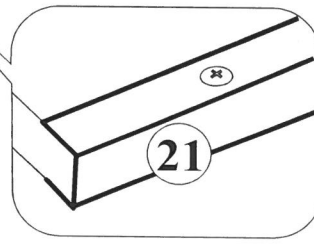
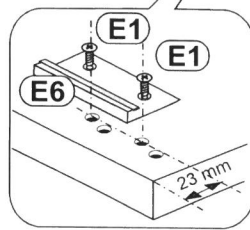

10

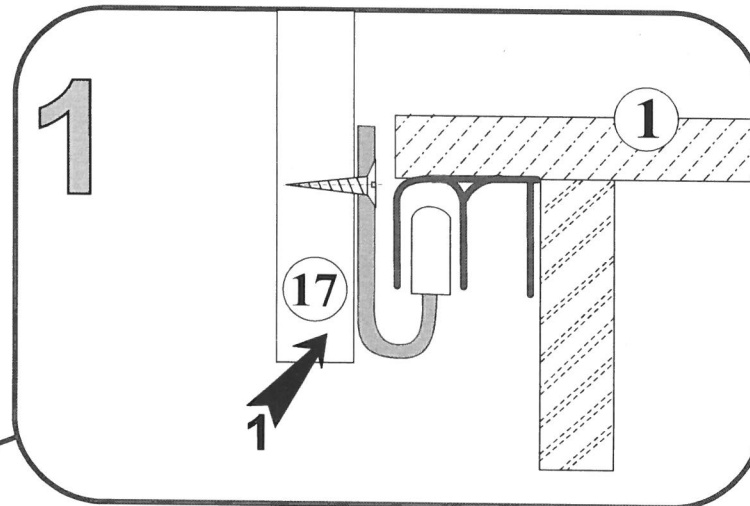
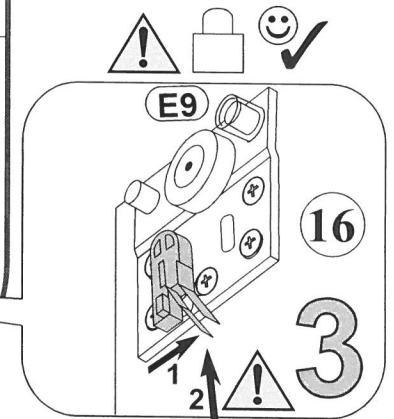
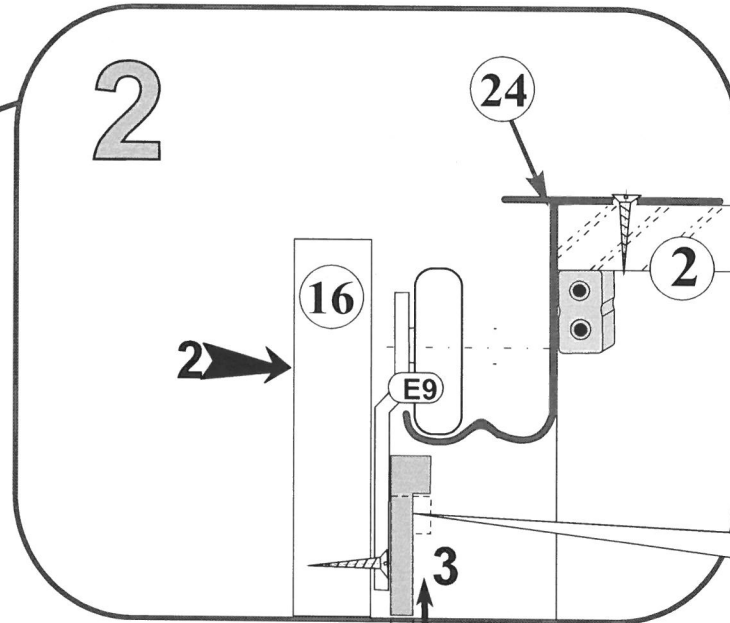
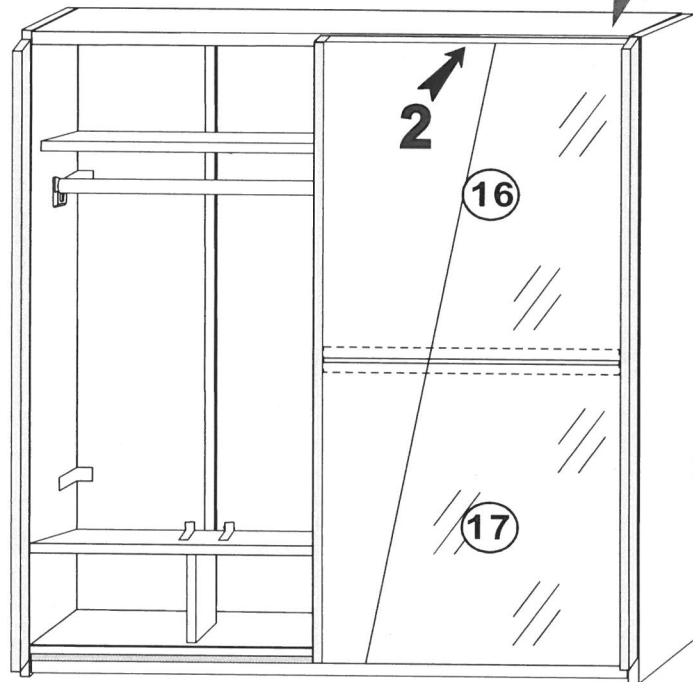
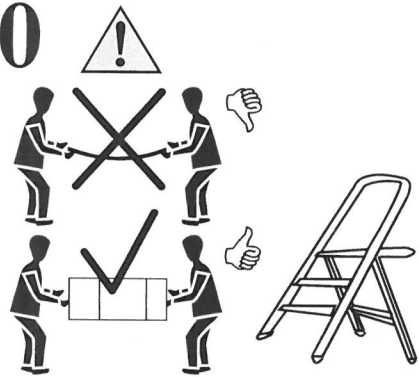

11

